

botek[®]

DEEP HOLE DRILLING SYSTEMS
SOLID CARBIDE TOOLS

2-Flute Drills

Type 120, 122
123, 125



botek



The botek company

Manufacturing deep and precise holes is a technical challenge when processing metal. Accordingly specialising in deep hole drilling technology was the founding idea in 1974 of botek Präzisionsbohrtechnik GmbH in Riederich.

botek grew to be an international supplier of deep hole drilling tools. Over 500 employees in the main company develop and manufacture single and two fluted drills, deep hole drilling tools BTA and Ejector systems as well as special tools.

A complete product program, regarding all deep hole drilling aspects and a team of highly qualified and dedicated cutting specialists make botek a competent partner for the automobile industry and their suppliers, shipbuilding industry, hydraulic and aircraft industry as well as motor, gear and machine building companies.



- Our General Standard Terms and Conditions, which we assume as known, apply.
- We reserve the right to make modifications in the interests of technical improvement. Such modifications cannot, in principle, be accepted as justifiable reasons for complaint.
- Subject to change without prior notice. Errors excepted.

© botek Präzisionsbohrtechnik GmbH



Contents

- p. 2 The botek company
- p. 2 Important information
- p. 3 Contents

Tools

- p. 4 Advantages
- p. 5 The gundrilling process and the requirements for application

Solid carbide 2-flute drills

Type 123

- p. 6 Overview
- p. 6 Tool design
- p. 6 Nose grind geometry
- p. 7 Shank / Driver (overview)
- p. 8 Technical information

2-flute drills with brazed carbide tip

Type 120 / Type 122 / Type 125

- p. 9 Overview
- p. 9 Tool design
- p. 9 Standard nose grind
- p. 10 Driver
- p. 11 Driver
- p. 12 Technical information

Technical appendix

- p. 13 Regrinding instruction for standard nose grind Type 120 / Type 123
- p. 14 Service
- p. 15 Accessories
- p. 16 Axial-Pulsator
- p. 17 Drilling quality
- p. 18 Application notes

Inquiry / Order

- p. 19 Inquiry form / Order form

Advantages

1. Cost effective and precise holemaking.
2. Higher feed rate possible.
3. Best drilling quality.
4. High process reliability.
5. Tool lengths up to 1,200 mm – depending on tool type and tool diameter.
6. Suitable for use on machining centres and turning machines with high pressure coolant system.
7. Minimum quantity lubrication (MQL) possible under certain conditions.
8. Drills can be used horizontally or vertically with either tool, workpiece or counterrotation.
9. Tools can be reground – at botek or in your facility.
10. Ideally suited to drill short chipping materials like Alu-alloys and cast iron.
11. Nose grinds with chip breaker for optimum chip formation available.
12. With the botek „Axial-Pulsator“ drill Type 120 and 123 are also suitable drilling steel and other long chipping materials.
13. With the „Axial-Pulsator“ higher feed rates can be achieved.

Axial-Pulsator



The botek „Axial-Pulsator“ has been developed to increase the feed rate of straight fluted deep hole drilling tools, particularly drilling steel and other long chipping materials.

For additional information please refer to page 16.

The gundrilling process and the requirements for application

The characteristic of the 2-flute drilling process is that coolant is fed through the coolant holes in the tool and exits along with the chips in the flutes from the drilled hole. The coolant also provides lubrication to the drill periphery.

Conditions for successful deep hole drilling

1. An efficient coolant and filtration system with a filtration of 20 µm to 30 µm (the smaller the diameter, the better the coolant and filtration should be).
2. Suitable coolant, i. e. deep hole drilling oil or emulsion (min. 10-12 % concentration, with e. p. additives) has to be provided in sufficient quantity and pressure. Minimum quantity lubrication (MQL) may be used under certain conditions.
3. Drill guiding through drill bush or pilot hole in the workpiece.

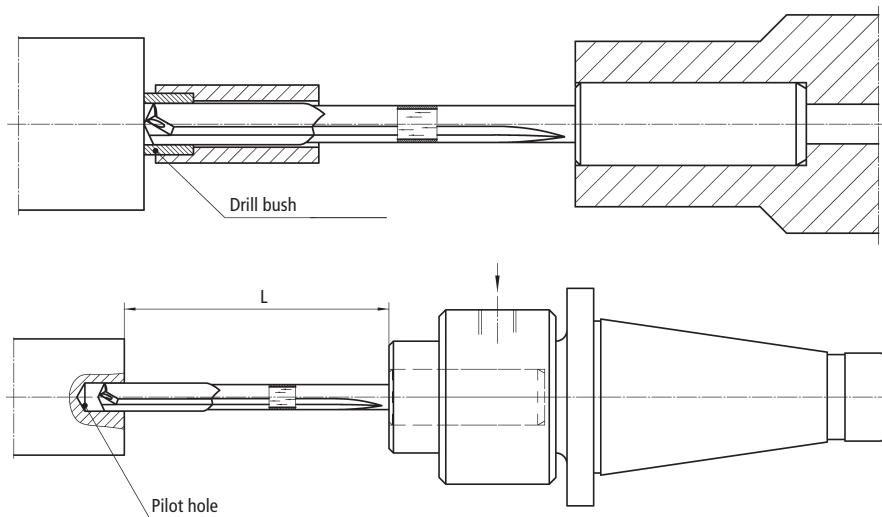

The 2-flute gundrill is not self centering. When positioning the drill, the tool must be guided through a drill bush or a pilot hole. The quality of the guide hole affects the drilling performance (tool life, centreline deviation, etc.).

Dimensions for the guide hole



	Drill diameter (mm)	Dimensions for guide hole (pilot hole)	
		L (mm)	D (mm) ISO Tolerance F7
	2.800 - 6.000 mm	ca. 1.5 x D	+ 0.010 to 0.022
	6.001 - 10.000 mm		+ 0.013 to 0.028
	10.001 - 18.000 mm	ca. 1.0 x D	+ 0.016 to 0.034
	18.001 - 32.000 mm		+ 0.020 to 0.041

For precise holes we recommend to use the ISO tolerance G6. The dimensions specified in the table are guide values. To avoid chipping to the cutting edge, a chamfered pilot hole (F) is recommended depending on the machining requirements. Please refer to application notes on page 18.

Solid carbide 2-flute drills

Type 123

Overview

Type	Tool diameter	
Type 123 Solid carbide 2-flute drill coolant fed double margin	tool diameter 2.800 – 32.000 mm	
Type 123-01 Solid carbide 2-flute drill for taps, coolant fed, step angle 90°	tool diameter 2.800 – 32.000 mm	
Type 123-02 Solid carbide 2-flute step drill for taps, coolant fed, step angle 180°	tool diameter 2.800 – 32.000 mm	

Type 123 available on request with cutting edge with PCD

Tool design

Drill and head shaft are manufactured from a single piece of carbide blank. The advantage of this tool is high process reliability and performance. Longer tool life is possible due to reduced torsional vibrations and higher rigidity.

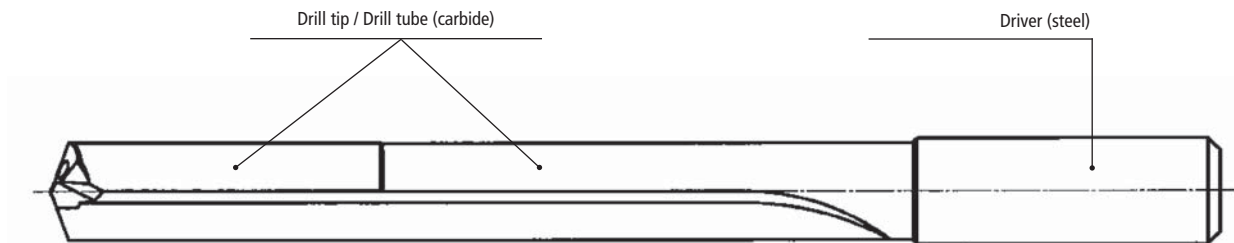

Nose grind geometry

The nose grind geometry affect the following, hole tolerance, chip formation, coolant pressure and flow, tool life, centreline deviation and surface quality. Over the years, botek has successfully tested a number of different nose grinds for drilling various materials.

botek's experience has formed the foundation for the development of our standard nose grind geometries. This meets the requirements of most drilling applications. Drilling of especially long chipping materials and difficult to machine materials usually call for special nose grind geometries, and in some cases, made to order chip breakers, all available from botek.

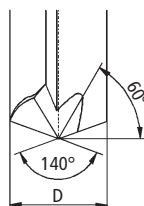





→ Instructions for regrinding: see page 13.

Solid carbide 2-flute drills

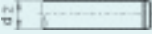
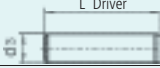
Type 123

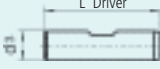
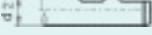
Shank / Driver

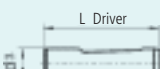
Shank	d2 (Type 123-00) d3 (Type 123-01/Type 123-02)	Driver	d3 (mm)	L Driver (mm)
DIN 6535 HAK 	6 8 10 12 14 16 18 20 25 32	DIN 6535 HAK 	10 12 16 20 25	40 45 48 50 56
DIN 6535 HBK 	6 8 10 12 14 16 18 20	DIN 6535 HBK 	10 12 16 20 25	40 45 48 50 56
	25 32		32 40	60 70
DIN 6535 HEK 	6 8 10 12 14 16 18 20 25 32	DIN 6535 HEK 	10 12 16 20 25 32 40	40 45 48 50 56 60 70
		Special driver	as per drawing	as per drawing

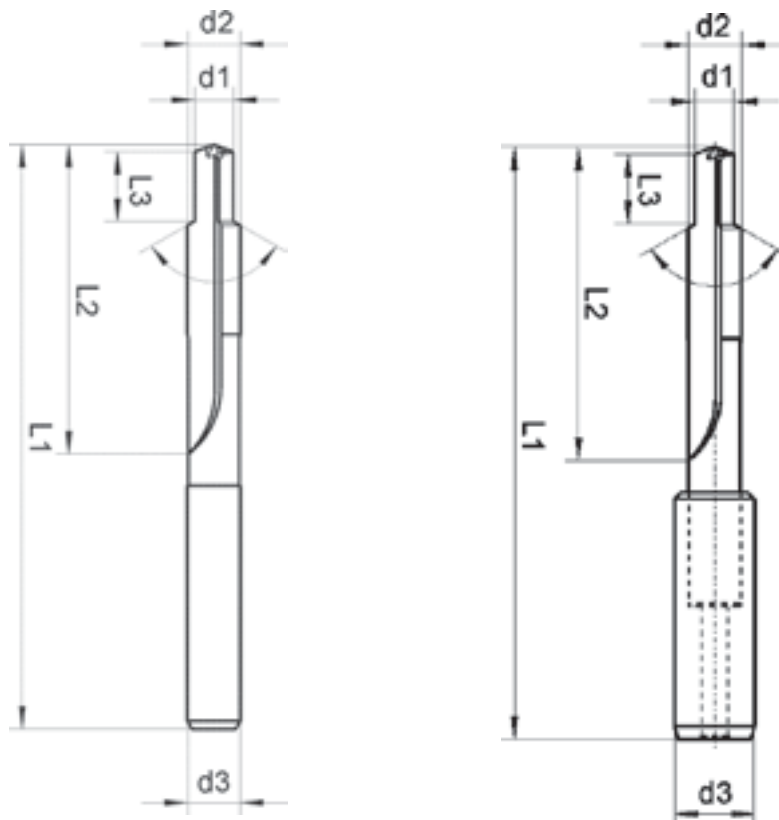

Please note:

- DIN 6535 HAK is standard. Other shank or driver design on request only.
- Alle Schaftformen mit optimierter Schafttoleranz zur Aufnahme in Hydrodehnspannfutter.

Technical information

Type 123

Guide values for drilling of various materials with solid carbide 2-flute drill Type 123

Material	Mechanical strength	Examples	Cutting speed Vc (m/min), Values for guide hole with pilot hole	Cutting speed Vc (m/min), Adjusted Values for guide hole without pilot hole				Feed rate f (mm), referred to tool diameter				
				3 x D	5 x D	8 x D	12 x D	3.0-4.99	5.0-7.99	8.0-11.99	12.0-15.99	16.0-20.0
General steel castings	≤ 600 N/mm ²	GS 38	30 - 60	27.0 - 54.0	24 - 48	21.0 - 42.0	18 - 36	0.05 - 0.15	0.05 - 0.20	0.10 - 0.22	0.10 - 0.25	0.10 - 0.28
	≤ 700 N/mm ²	GS 52	25 - 50	22.5 - 45.0	20 - 40	17.5 - 35.0	15 - 30	0.04 - 0.10	0.05 - 0.16	0.05 - 0.19	0.08 - 0.20	0.08 - 0.22
	> 700 N/mm ²	GS 62	20 - 45	18.0 - 40.5	16 - 36	14.0 - 31.5	12 - 27	0.04 - 0.10	0.05 - 0.16	0.05 - 0.19	0.08 - 0.20	0.08 - 0.22
Cast iron/ Grey cast iron	≤ 200 HB	GG 30	70 - 115	63.0 - 103.5	56 - 92	49.0 - 80.5	42 - 69	0.10 - 0.25	0.15 - 0.32	0.20 - 0.40	0.25 - 0.45	0.30 - 0.50
		GGG 50	70 - 115	63.0 - 103.5	56 - 92	49.0 - 80.5	42 - 69	0.10 - 0.25	0.15 - 0.32	0.20 - 0.40	0.25 - 0.45	0.30 - 0.50
		GTW 40	70 - 115	63.0 - 103.5	56 - 92	49.0 - 80.5	42 - 69	0.10 - 0.25	0.15 - 0.32	0.20 - 0.40	0.25 - 0.45	0.30 - 0.50
	> 250 HB	GG 30	60 - 95	54.0 - 85.5	48 - 76	42.0 - 66.5	36 - 57	0.10 - 0.20	0.12 - 0.25	0.15 - 0.35	0.20 - 0.40	0.25 - 0.45
		GGG 50	60 - 95	54.0 - 85.5	48 - 76	42.0 - 66.5	36 - 57	0.10 - 0.20	0.12 - 0.25	0.15 - 0.35	0.20 - 0.40	0.25 - 0.45
		GTW 400	60 - 95	54.0 - 85.5	48 - 76	42.0 - 66.5	36 - 57	0.10 - 0.20	0.12 - 0.25	0.15 - 0.35	0.20 - 0.40	0.25 - 0.45
Nodular cast iron	350 HB		20 - 55	18.0 - 49.5	16 - 44	14.0 - 38.5	12 - 33	0.04 - 0.10	0.06 - 0.12	0.08 - 0.15	0.08 - 0.15	0.10 - 0.20
	450 HB		20 - 55	18.0 - 49.5	16 - 44	14.0 - 38.5	12 - 33	0.04 - 0.10	0.06 - 0.12	0.08 - 0.15	0.08 - 0.15	0.10 - 0.20
Copper Bronze Brass Plastics		Copper	60 - 220	54.0 - 198.0	48 - 176	42.0 - 154.0	36 - 132	0.07 - 0.18	0.12 - 0.25	0.20 - 0.35	0.25 - 0.45	0.30 - 0.50
		Bronze	60 - 220	54.0 - 198.0	48 - 176	42.0 - 154.0	36 - 132	0.07 - 0.18	0.12 - 0.25	0.20 - 0.35	0.25 - 0.45	0.30 - 0.50
		Brass	60 - 220	54.0 - 198.0	48 - 176	42.0 - 154.0	36 - 132	0.07 - 0.18	0.12 - 0.25	0.20 - 0.35	0.25 - 0.45	0.30 - 0.50
Aluminium		< 10% Si	80 - 300	72.0 - 270.0	64 - 240	56.0 - 210.0	48 - 180	0.20 - 0.40	0.20 - 0.40	0.20 - 0.40	0.20 - 0.40	0.20 - 0.40
Aluminium		> 10% Si	70 - 200	63.0 - 180.0	56 - 160	49.0 - 140.0	42 - 120	0.10 - 0.25	0.15 - 0.35	0.25 - 0.45	0.30 - 0.50	0.35 - 0.55

Please note:

- Guide values only.
- Coated drills may produce different chip formation (often longer chips).
- Use adequate feed rate to produce short but not compressed chips.
- High cutting efficiency is only possible if troublefree chip evacuation is guaranteed (see coolant diagram).

Coolant pressure and Coolant quantity

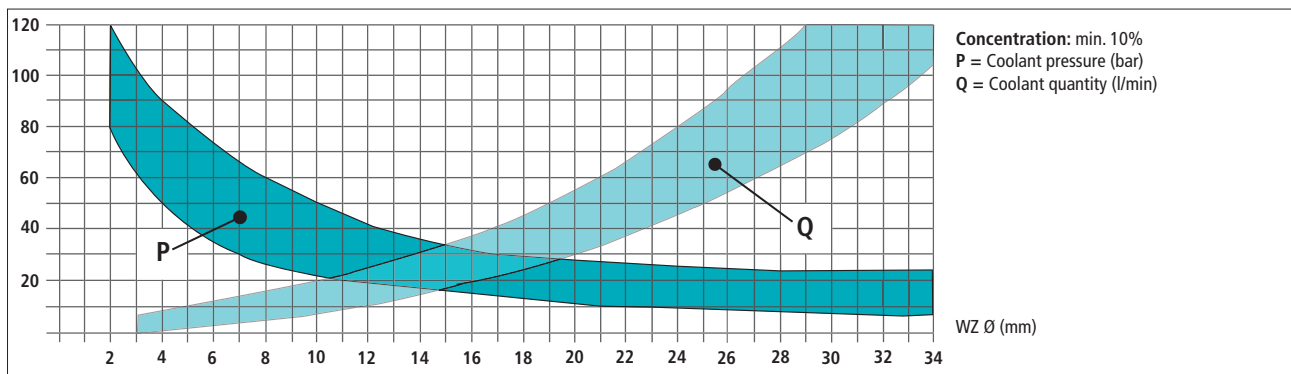





Please note:

- Optimum tool clamping (hydraulic chuck, shrink fit) ensure best results in surface quality and hole straightness.
- Reduced feed rate during interrupted cut, cross holes and angle entry or exit.

2-flute drills with brazed carbide tip Type 120 / Type 122 / Type 125

Overview

Type	Tool diameter	
Type 120 2-flute drill with solid carbide tip	tool diameter 6.000 – 26.500 mm	
Type 122 2-flute stepped solid drilling tool with solid carbide tip	tool diameter 4.510 – 26.500 mm	
Type 125 2-flute counterboring tool with solid carbide tip	tool diameter 4.000 – 40.000 mm	
Type 125-03 2-flute counterboring tool with guiding pilot with solid carbide tip and steel shank	tool diameter 6.000 – 26.500 mm	

Type 120 available on request with cutting edge with PCD

Tool design

The botek 2-flute drill is fabricated with a drill head section of solid carbide tip, which is brazed to a heat treated tube (flute) section then fitted and brazed to a hardened and ground steel driver.

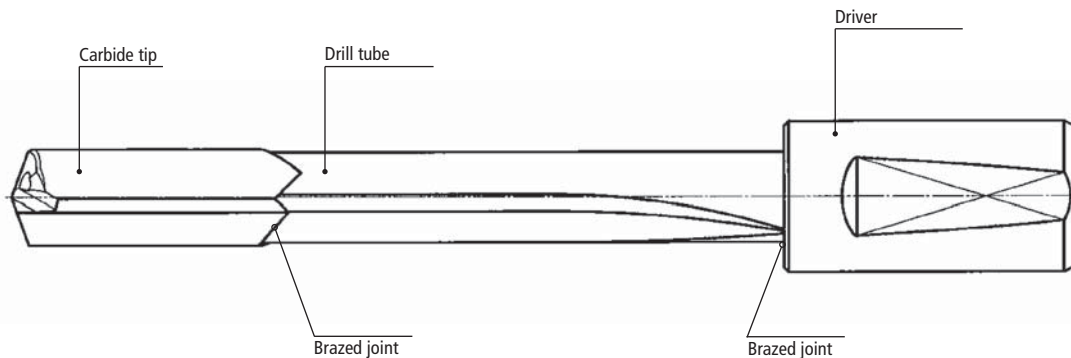

Standard nose grind

The nose grind geometry affect the following, hole tolerance, chip formation, coolant pressure and flow, tool life, centreline deviation and surface quality. Over the years, botek has successfully tested a number of different nose grinds for drilling various materials.

botek's experience has formed the foundation for the development of our standard nose grind geometries. This meets the requirements of most drilling applications. Deep-hole drilling of especially long chipping materials and difficult to machine materials usually call for special nose grind geometries, and in some cases, made to order chip breakers, all available from botek.

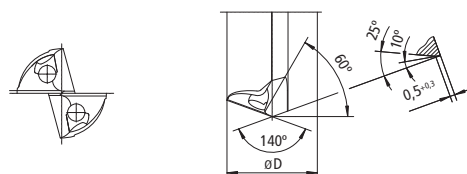

→ Instructions for regrinding: see page 13.

2-flute drills with brazed carbide tip

Type 120 / Type 122 / Type 125

3. Driver

2-flute drills are typically provided with a driver for holding the tool in the machine spindle. The driver transmits the torque from the machine spindle.

botek provides a variety of standard drivers from stock as well as customer specific configurations.

Standard drivers for 2-flute gundrills with brazed carbide tip – Overview

Designation		Drawing	botek driver no.	for tool length calculation			X = Notch location	M = Thread size
Ø dia. (mm)	Type			Drill dia. range (mm) from - to	L Driver	L Driver with pin		
10			ZH10-00	1.850 - 7.299	40		24.0	
16			ZH16-03	1.850 - 12.399	45	53	31.0	
25			ZH25-00	7.300 - 19.509	70	78	34.0	
10	with pin		ZH10-01	7.300 - 12.399	40	57	24.0	
16			ZH16-04	12.400 - 20.500	45	72	31.0	
25	with pin and drive key		ZH25-01	19.510 - >	70	105	34.0	
16			ZH16-02	1.850 - 12.399	50	58	47.5	
16	with pin		ZH16-33	12.400 - 20.500	50	77	47.5	
10	GKT with metr. thread		ZH10-06	1.850 - 7.299	60			M6x0.5
16			ZH16-15	1.850 - 12.399	80			M10x1
25			ZH25-08	6.000 - 20.509	100			M16x1.5
10	GKT with metr. thread with pin		ZH10-28	7.300 - 12.390	60	77		M6x0.5
16			ZH16-22	12.400 - 20.500	80	105		M10x1
25			ZH25-10	20.510 - >	100	140		M16x1.5
12.7	1/2" 3/4" 1" 1 1/4" 1 1/2"		ZH12,7-00	1.850 - 9.699	38,1		25.3	
19.05			ZH19,05-01	3.960 - 14.899	70		45.0	
25.4			ZH25,4-00	6.000 - 19.509	70		57.5	
31.7			ZH31,7-00	9.700 - 25.609	70		57.5	
38.1			ZH38,1-00	9.700 - 32.609	70		57.5	
19.05	3/4" 1" 1 1/4" 1 1/2" inch dia. with pin		ZH19,05-11	14.900 - 24.609	70	97	45.0	
25.4			ZH25,4-01	19.510 - >	70	100	57.5	
31.7			ZH31,7-01	25.610 - >	70	110	57.5	
38.1			ZH38,1-01	32.610 - >	70	110	57.5	
10	VDI 3208		ZH 10-44	1.850 - 6.749	60	68	35	M6x0.5
16			ZH 16-31	1.850 - 10.799	80	90	37	M10x1
25			ZH 25-34	6.000 - 19.509	100	112	45	M16x1.5
16	VDI 3208 with pin		ZH 16-66	10.800 - 16.399	80	110	37	M10x1
25			ZH 25-40	19.510 - 42.699	100	142	45	M16x1.5

2-flute drills with brazed carbide tip

Type 120 / Type 122 / Type 125

Standard drivers for 2-flute drills with brazed carbide tip – Overview

Designation		Drawing	brotek driver no.	for tool length calculation			X = Notch location	TR = Thread size		
Ø dia. (mm)	Type			Drill dia. range (mm) from - to	L Driver	L Driver with pin				
16	Adjustable driver with acme thread		SH16-00	1.850 - 12.899	112		73.0	TR16x1.5		
20			SH20-00	1.850 - 14.899	126		82.0	TR20x2		
28			SH28-00	6.000 - 21.509	126		82.0	TR28x2		
36			SH36-00	8.700 - 28.609	162		109.0	TR36x2		
16	Speedbit		ZH16-21	1.850 - 12.399	40		28.0			
25			ZH25-16	6.750 - 19.509	50		35.0			
35			ZH35-00	9.700 - 28.609	60		40.0			
16	Speedbit with pin		ZH16-30	12.400 - 20.509	40	67	28.0			
25			ZH25-20	19.510 - 30.609	50	77	35.0			
35			ZH35-01	28.610 - >	60	100	40.0			
10			DIN 6535-HA		ZH10-40	1.850 - 7.299	40			
12	ZH12-18	1.850 - 8.999			45					
16	ZH16-11	1.850 - 12.399			48					
20	ZH20-01	5.000 - 15.899			50					
25	ZH25-11	6.000 - 19.509			56					
32	ZH32-24	9.700 - 25.609			60					
40	ZH40-03	9.700 - 32.609			70					
10	DIN 6535-HA or 1835-A with pin		ZH10-41	7.300 - 12.399	40	57				
12			ZH12-19	9.000 - 15.899	45	62				
16			ZH16-20	12.400 - 20.509	48	75				
20			ZH20-60	15.900 - 25.603	50	77				
25			ZH25-21	19.510 - 34.699	56	86				
32			ZH32-23	25.610 - 45.699	60	100				
40			ZH40-04	32.610 - >	70	110				
10	DIN 6535-HB		ZH10-11	1.850 - 7.299	40		23.5			
12			ZH12-07	1.850 - 8.999	45		26.5			
16			ZH16-32	1.850 - 12.399	48		29.0			
20			ZH20-29	1.850 - 15.899	50		30.5			
25	DIN 6535-HB		ZH25-22	6.000 - 19.509	56		38.0			
32	DIN 1835-B32		ZH32-10	9.700 - 25.609	60		43.0			
40	DIN 1835-B40		ZH40-13	9.700 - 32.609	70		47.0			
10	DIN 6535-HA or 1835-A with pin		ZH10-23	7.300 - 12.399	40	57	23.5			
12			ZH12-02	9.000 - 15.899	45	62	26.5			
16			ZH16-53	12.400 - 20.500	48	75	29.0			
20			ZH20-34	15.900 - 25.609	50	77	30.5			
25			ZH25-31	19.510 - >	56	86	38.0			
32			ZH32-11	25.610 - >	60	100	43.0			
40			ZH40-14	32.610 - >	70	110	47.0			
10			DIN 1835-E		ZH10-20	1.850 - 7.299	40		28.0	
12					ZH12-08	1.850 - 8.999	45		33.0	
16					ZH16-47	1.850 - 12.399	48		36.0	
20	ZH20-40	1.850 - 15.899			50		38.0			
25	ZH25-36	6.000 - 19.509			56		44.0			
32	ZH32-12	9.700 - 25.609			60		48.0			
40	ZH40-18	9.700 - 32.609			70		66.0			
10	DIN 1835-E with pin				ZH10-24	7.300 - 12.399	40	57	28.0	
12			ZH12-05	9.000 - 15.899	45	62	33.0			
16			ZH16-51	12.400 - 20.500	48	75	36.0			
20			ZH20-43	15.900 - 29.609	50	77	38.0			
25			ZH25-37	19.510 - >	56	86	44.0			
32			ZH32-13	25.610 - >	60	100	48.0			
40			ZH40-17	32.610 - >	70	110	66.0			
10	DIN 6535-HE		ZH10-29	1.850 - 7.299	40		28.0			
12			ZH12-13	1.850 - 8.999	45		33.0			
16			ZH16-62	1.850 - 12.390	48		36.0			
20			ZH20-55	1.850 - 15.899	50		38.0			
10	DIN 6535-HE with pin		ZH10-30	7.300 - 12.399	40	57	28.0			
12			ZH12-14	9.000 - 12.399	45	62	33.0			
16			ZH16-70	12.400 - 20.500	48	75	36.0			
20			ZH20-56	15.900 - 29.609	50	77	38.0			

Technical information

Type 120/Type 122/Type 125

Guide values for drilling of various materials

Material groups	Cast iron Grey cast iron ($< 300 \text{ N/mm}^2$) Nodular cast iron ($< 400 \text{ N/mm}^2$) Malleable cast iron	Cast iron Grey cast iron ($< 300 \text{ N/mm}^2$) Nodular cast iron ($< 400 \text{ N/mm}^2$) Steel castings	Copper Bronze Brass Plastics	Aluminium + Aluminium alloys Si-content $> 5\%$ „easily workable“
	Cutting speed m/min	70 - 100	60 - 90	70 - 120
Drill diameter (mm)	Feed rate (mm) / rev.			
	from - to	from - to	from - to	from - to
6.0 - 7.99	0.04 - 0.08	0.03 - 0.07	0.04 - 0.08	0.06 - 0.13
8.0 - 9.99	0.05 - 0.11	0.05 - 0.10	0.05 - 0.11	0.09 - 0.18
10.0 - 13.99	0.08 - 0.16	0.07 - 0.14	0.08 - 0.16	0.12 - 0.24
14.0 - 17.99	0.10 - 0.21	0.09 - 0.18	0.10 - 0.21	0.16 - 0.32
18.0 - 21.99	0.13 - 0.26	0.10 - 0.21	0.13 - 0.26	0.19 - 0.38
> 22.0	0.15 - 0.31	0.12 - 0.25	0.15 - 0.31	0.22 - 0.44

Cutting speed and feed rate are dependent on tool length, coolant type and materials. In addition, the stability of the machine and workpiece clamping. All figures specified are guide values.

Coolant quantity

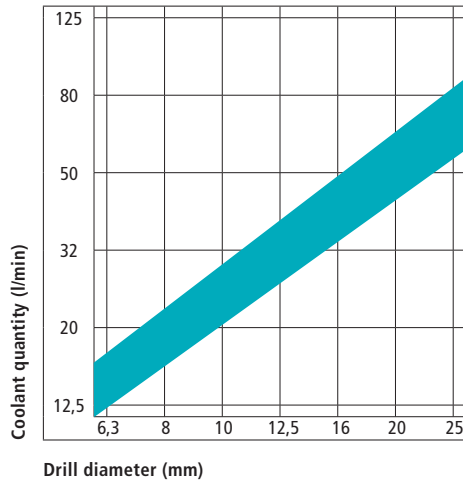

Coolant pressure

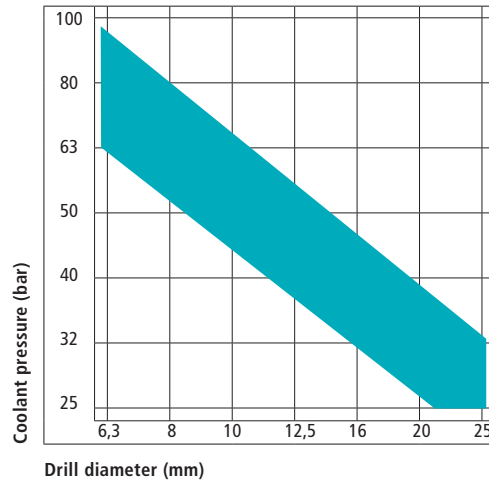

Reliable chip removal is only assured if sufficient coolant is supplied to the tool. The diagrams show our recommendation for coolant pressure and quantity by drill diameter.

The ideal **viscosity of deep-hole drilling oil** should be $15 \text{ mm}^2/\text{s}$ (60 - 70 SUS) at 40°C for drilling diameters up to 18 mm.

When using emulsion, the specified pressures (p) may be reduced by up to $\sim 20\%$.

For all drill diameters filtering is required between $5 \mu\text{m}$ and $20 \mu\text{m}$.

Technical appendix

Regrinding instruction for standard nose grind Type 120 / Type 123

Regrinding instruction

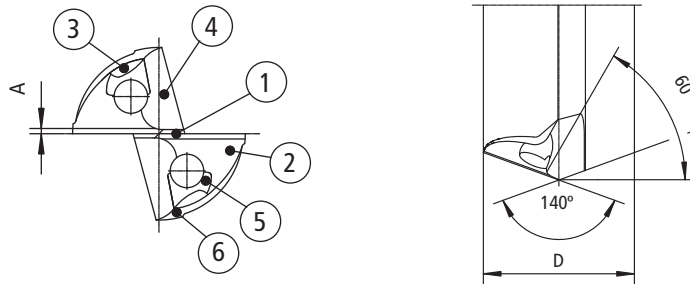

Fixture settings and grinding sequence

Operation	Swing 	Tilt 	Torsion 	Gage	Remarks
1	20°	10°	0°	A	cutting land 2 nd edge 180°
2	20°	Ø 3.000 - 6.009 25° Ø 6.010 - 25.000 20°	0°		relief angle 2 nd edge 180°
3	10°	35°	0°		relief angle 2 nd edge 180°
4	60°	0°	grinding wheel 15°	Q	web thinning 2 nd edge 180°
5	15°	0°	0°		grinding into half of the coolant hole
6	60°	0°		C	grinding land hand chamfer

Dimensions (mm)

Drill-Ø	A Cutting land	Q Web thickness + 0.1	C Chamfer	R Radius
3.000 - 6.009	0.4	0.4	0.5	1.0
6.010 - 10.009	0.4	0.5	0.5	1.0
10.010 - 15.009	0.5	0.6	0.6	1.5
15.010 - 20.009	0.6	0.8	0.7	2.0
20.010 - 25.000	0.7	0.9	0.8	2.5

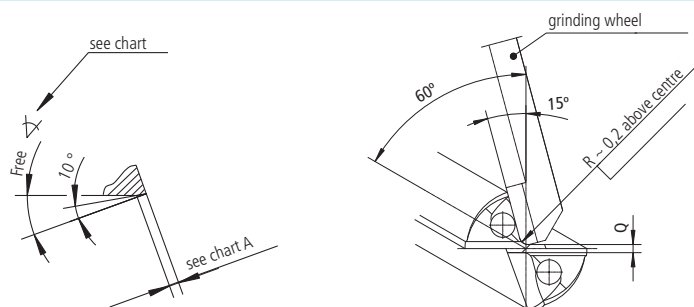

Technical appendix

Service

Coating

2-flute drills can be supplied with various coatings. The coating depends on the material to be drilled, cutting fluid and drilling situation.

Regrinding

botek offers an individual regrinding service.

Retipping

2-flute drills with brazed carbide tip can be retipped.

If you have any questions, please do not hesitate to contact us or refer to: www.botek.de

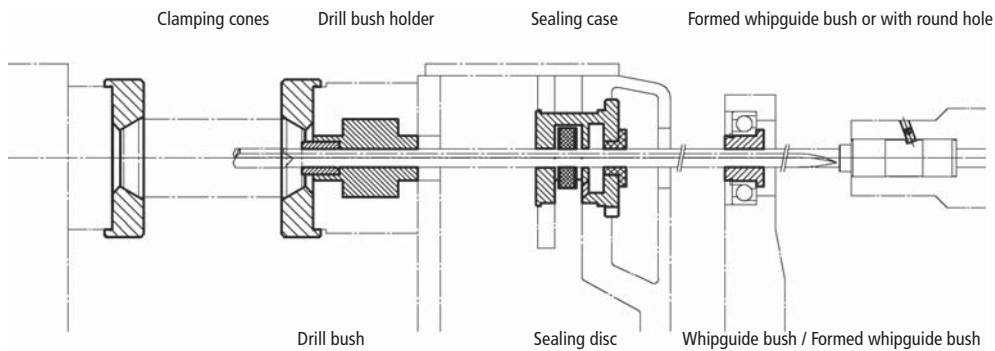

Whipguide bush with round hole	Tool diameter (mm)	D	L	I1	d	Drawing no.	botek order no.
	1.850 - 15.399	25	22	12	Please specify tool dia. and outer dia. (D) when ordering	170-05-4-1060	792 000 509
	1.850 - 25.609	30	26	16		170-05-4-1238	792 000 511
	1.850 - 36.699	45	26	14		170-05-4-1341	792 000 512
	1.850 - 25.609	35	26	14		170-05-4-2227	792 000 510
	1.850 - 25.609	30	26	13		170-05-4-2278	792 000 513
	1.850 - 36.699	45	26	16		170-05-4-2279	792 000 514
	1.850 - 11.799	20	22	12		170-05-4-2650	792 000 508
	1.850 - 32.609	40	26	15		170-05-4-3897	792 000 515
Formed whipguide bush	Tool diameter (mm)	D	L	I1	d	Drawing no.	botek order no.
	5.000 - 12.399	20	20	12	Please specify tool dia. and outer dia. (D) when ordering	170-05-4-1813	792 000 533
	5.000 - 22.899	30	26	14		170-05-4-1814	792 000 522
	7.800 - 27.000	45	26	16		170-05-4-1815	792 000 534
Whipguide bush	Tool diameter (mm)	D	L	d	Drawing no.	botek order no.	
	2.800 - 12.399	22.6	15	Please specify tool dia. when ordering		170-05-4-1180	792 000 535
Sealing disc	Tool diameter (mm)	D	L	d	Drawing no.	botek order no.	
	5.000 - 22.899	32	4	Please specify tool dia. when ordering	170-07-4-1417	792 000 531	
	5.000 - 27.000	40	4			792 000 532	
Special sealing disc	Tool diameter (mm)	D	L	d	Drawing no.	botek order no.	
	5.000 - 5.749	32	12	Please specify tool dia. when ordering	170-07-4-142204	792 000 527	
	5.750 - 6.749				170-07-4-142205		
	6.750 - 7.599				170-07-4-142206		
	7.600 - 8.699				170-07-4-142207		
	8.700 - 9.999				170-07-4-142208		
	10.000 - 11.299				170-07-4-142209		
	11.300 - 12.899				170-07-4-142210		
	12.900 - 14.399				170-07-4-142211		
	14.400 - 16.399	170-07-4-142212			792 000 528		
	16.400 - 17.899	170-07-4-142213					
	17.900 - 20.799	170-07-4-142214					
	20.800 - 22.899	170-07-4-142215					
	22.900 - 24.899	170-07-4-142216					
	24.900 - 27.000	170-07-4-142217					
Drill bushings to DIN 179A	Cylindrical drill bushings to DIN 179A in middle version 170-04 made from hardened tool steel			d	Drawing no.	botek order no.	
				Please specify tool dia. when ordering	170-04		

Technical appendix

Axial-Pulsator

Axial-Pulsator

The botek „Axial Pulsator“ has been developed to increase the feed rate of straight fluted deep hole drilling tools, particularly drilling steel and other long chipping materials.

The typical quality characteristics of single flute and 2-flute gundrills like excellent surface finish, minimum run out, hole straightness and hole roundness and high process reliability can be achieved very economical in combination with the „Axial Pulsator“.

Large Pulsator

Drill diameter: 4.0 mm to 12.0 mm
 Max. speed: 6,000 RPM
 Adjustable only by manufacturer (only stroke)
 Ø: 70 mm
 Weight: 4.4 kg
 L: 160 mm

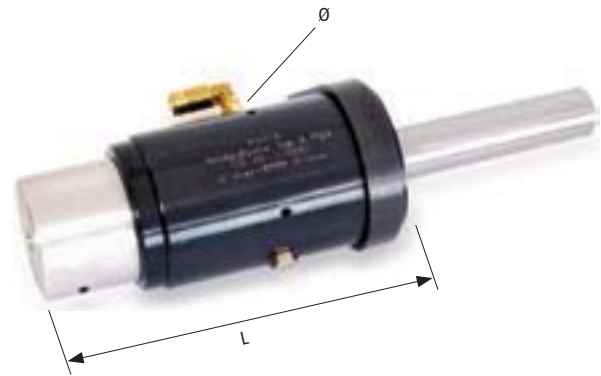

Small Pulsator

Drill diameter: up to 4.0 mm
 Max. speed: 11,000 RPM
 Adjustable stroke
 Ø: 50 mm
 Weight: 1.3 kg
 L: 140 mm

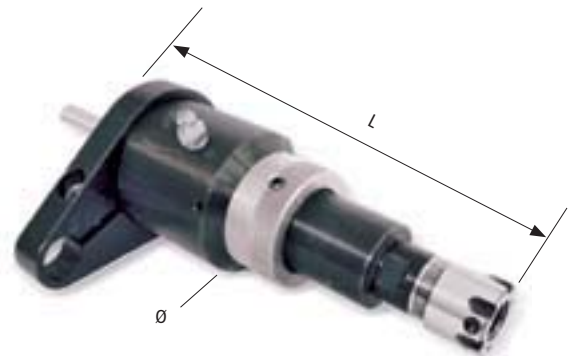

Alternative measurements on request.

Application example

Copper	without Pulsator	with Pulsator	with Pulsator
Tool	Single flute gundrill Type 110	Single flute gundrill Type 110	Solid carbide 2-flute drill Type 123
Diameter (mm)	8.0	8.0	8.0
V _f (mm/min)	40	120	200
Steel	without Pulsator	with Pulsator	with Pulsator
Tool	Single flute gundrill Type 110	Single flute gundrill Type 110	Solid carbide 2-flute drill Type 123
Diameter (mm)	8.0	8.0	8.0
V _f (mm/min)	90 - 100	150 - 180	200 - 1000

Above mentioned values are guide values which could differ from your application.

If you have any questions, please email to: pulsator@botek.de.

We will be pleased to offer you advice.

Drilling quality

To achieve optimum drilling results when using carbide tipped or solid carbide gundrills, various criteria must be applied. In addition to tool design, key factors are machine design and construction, process techniques, pressurized and filtered deep hole drilling coolant. Selection of proper cutting parameters is also a significant factor.

The key factors botek considers when designing gundrills:

- Material type
- Diameter, tolerance and surface finish
- Peripheral contour
- Carbide grade and coating
- Nose grind geometry

In addition to our refined manufacturing and technology for consistent product quality, our application and technical experience help you realize optimal solutions.

Achievable drilling tolerances

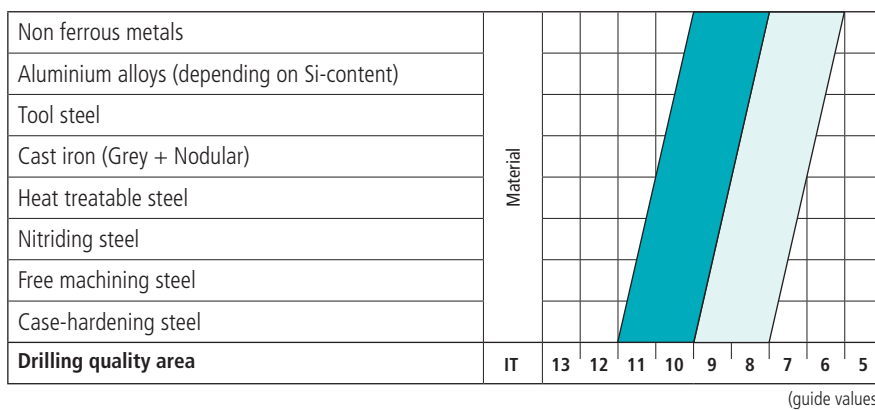

under normal conditions
 under favourable conditions

Surface quality

Roughness class		N8	N7	N6	N5	N4	N3
Quality area							
Surface roughness values	Rt μm	21	11.5	6.2	3.4	1.9	1.0
	Ra μm	3.2	1.6	0.8	0.4	0.2	0.1
	Rz μm	14	7.6	4.5	2.2	1.2	0.65

(guide values)

under normal conditions
 under favourable conditions

Drilling sequence:

1. Drilling pilot hole (dimensions see table page 5).
2. Feed gundrill into pilot hole while non rotating or rotating slowly ($< 50 \text{ U / min}$).
3. Switch on the coolant.
4. Switch on spindle rotation and feed.
5. After reaching the drilling depth switch off coolant and spindle rotation.
6. Switch off coolant.
7. Retract tool (maximum rotation not exceeding 200 rev. / min . without support). Take care for safety information (see backside).

Technical appendix

Application notes

1. **Before using the drills make sure the machine has the necessary equipment to do proper deep hole drilling. The machine should have suitable safety guarding for protection from cutting chips and coolant for operator.** Check with machine builder!
2. **Improper use or handling of deep hole drilling tools can cause serious injuries**, e.g. skin cuts from the cutting edge.
3. Deep hole drilling tools are not self centering and can be unbalanced. Therefore the drills must be guided during the start of **the drilling cycle** by means of a sufficiently long drill bush or pilot hole.

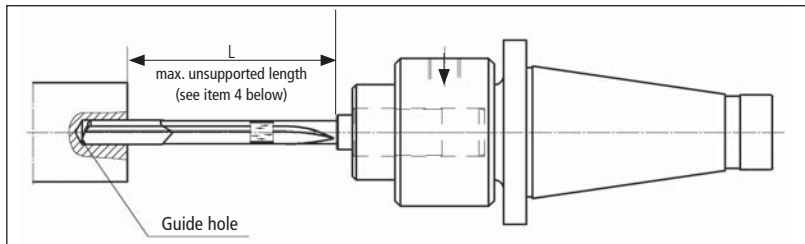

4. **Tool support: unsupported drill length** should never exceed the dimensions as shown on table. If the unsupported drill length is exceeded the drill might cause injury.

Maximum unsupported drill length (L) between the steady rests or in a guide hole.

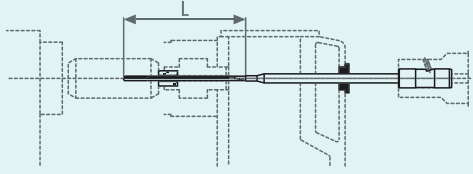
	2-flute drill	Drill dia. = D (mm)	Maximum unsupported drill length (L)
	Solid carbide		2.800 - 6.999
		7.000 - 12.000	approx. 60 x D
with brazed drill head		4.000 - 9.999	approx. 40 x D
		10.000 - 19.999	approx. 35 x D
		20.000 - 27.000	approx. 30 x D

Example 1: drill diameter, D = 2.0 mm, unsupported drill length up to maximum 80 mm = 40 x D

Example 2: drill diameter, D = 2.0 mm x 200 mm OAL, 1st support at 80 mm and 2nd support at 160 m

5. The gundrill is fed into a pilot hole **while non rotating** or rotated slowly at < 50 RPM (illustration). Then the coolant and the machine spindle should get started.
6. **After reaching the drilling depth** switch off the coolant and retract with the spindle stopped or slowly rotated at < 50 RPM.
7. Grinding of carbide produces dust (cobalt, etc.) that may be potentially hazardous. Use adequate ventilation and safety glasses during grinding.
8. **Consequences of not following** our application notes No. 1 - 7.

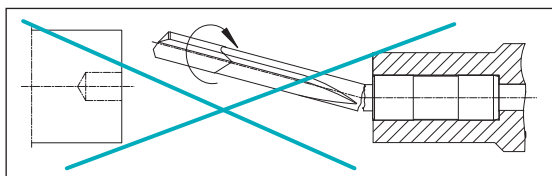

Using botek gundrills other than directed may cause personal injury.

Tool breakage and unsupported gundrills can be extremely dangerous.

Please use with caution and care.

Please note that all application notes and values contained herein are intended as guidelines only. We do not accept any liability for damages caused by improper handling of botek deep hole drilling tools, operating errors, unsuitable machinery or misuse while using our tools!

If you have any questions, please do not hesitate to contact us. P: +49 7123 38 08-0.



- Inquiry**
 Order (please mark with a cross where applicable)

FAX to +49 7123 3808-138

1) Drilling method **2) Driver**

- Type 120 Type 123
 Type 122 Type 123-01
 Type 125 Type 123-02

- Driver no. _____
(see botek order no. in catalogues)
 without driver
 Special driver
(please supply information on dimensions and version)

3) Tool dimensions (please fill in)

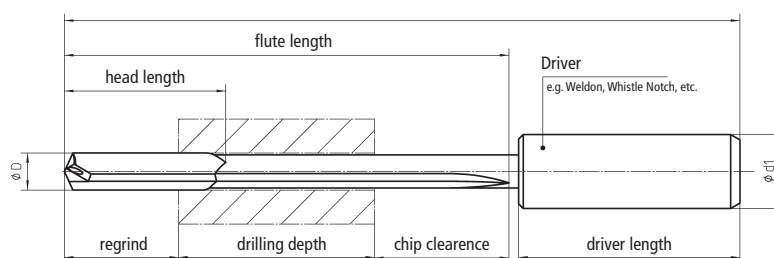

4) Calculation of tool length (mm):

Drill diameter	2.80 - 3.99	4.00 - 5.99	6.00 - 8.99	9.00 - 12.99	13.00 - 17.99	18.00 - 23.99	24.00 - 27.00
Regrind approx.	12	15	20	25	30	35	40
Clearance approx.	10	15	20	30	40	50	60

5) Nose Grinds **6) Coating**

Standard nose grind
You will find details of botek grindings in our gundrill brochure and under www.botek.de. You can also request this information directly from botek.

Special grind (as per drawing)

Coating type:

7) Drill hole diameter **8) Material**

_____ mm Material no.: _____ Description: _____ Hardness: _____

9) Machine / coolant **10) Notes, additional information** (on machining, use, material, etc.)

- Gundrilling machine Deep-hole drilling oil
 Machining centre Emulsion (min. 10%)
Coolant pressure(p): _____ bar

11) Quantity **12) Delivery date**

_____ piece(s) week _____

13) Customer info **14) Company stamp**

Customer: _____
Phone / Fax: _____
E-mail: _____
Contact: _____
Date / Signature: _____

botek[®]

DEEP HOLE DRILLING SYSTEMS
SOLID CARBIDE TOOLS

botek
Präzisionsbohrtechnik GmbH

Längenfeldstraße 4
72585 Riederich
Germany

P +49 7123 38 08-0
F +49 7123 38 08-138

Info@botek.de
www.botek.de

