

SCS 3D Drilling Tool | Ferramenta | Herramienta

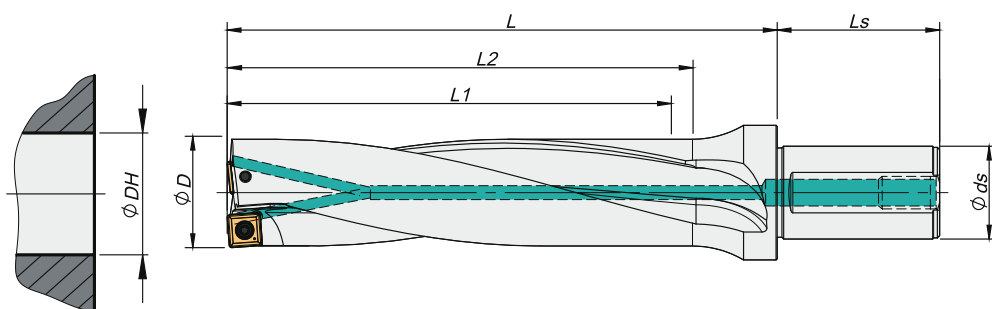



























ØDH tolerance (mm)	
ØD	3D
13,0 - 21,5	-0,10 / +0,15
22,0 - 50,0	-0,12 / +0,20

Øds	Ls	BP / SP
20	50	PT-1/8
25	56	PT-1/8
32	60	PT-1/4
40	70	PT-1/4

Order Code	Reference	Dimensions (mm)					Insert	Screw	Torx Key	Stock
		ØD	Øds	L1	L2	L				
184041400	SCS 13020-3D	13,0	20	39	42	62	SPKX 050204	P0200500	XT06	⊗
184041500	SCS 13520-3D	13,5	20	41	44	64	SPKX 050204	P0200500	XT06	⊗
184041600	SCS 14020-3D	14,0	20	42	45	65	SPKX 050204	P0200500	XT06	⊗
184041700	SCS 14520-3D	14,5	20	44	47	67	SPKX 050204	P0200500	XT06	⊗
184041800	SCS 15020-3D	15,0	20	45	48	68	SPKX 050204	P0200500	XT06	⊗
184041900	SCS 15525-3D	15,5	25	47	50	75	SPKX 060204	P0220500	XT07	⊗
184042000	SCS 16025-3D	16,0	25	48	51	76	SPKX 060204	P0220500	XT07	⊗
184042100	SCS 16525-3D	16,5	25	50	53	78	SPKX 060204	P0220500	XT07	⊗
184042200	SCS 17025-3D	17,0	25	51	54	79	SPKX 060204	P0220500	XT07	⊗
184042300	SCS 17525-3D	17,5	25	53	56	81	SPKX 060204	P0220500	XT07	⊗
184042400	SCS 18025-3D	18,0	25	54	57	82	SPKX 060204	P0220500	XT07	⊗
184042500	SCS 18525-3D	18,5	25	56	59	84	SPKX 060204	P0220500	XT07	⊗
184042600	SCS 19025-3D	19,0	25	57	60	85	SPKX 060204	P0220500	XT07	⊗
184042700	SCS 19525-3D	19,5	25	59	62	87	SPKX 060204	P0220500	XT07	⊗
184042800	SCS 20025-3D	20,0	25	60	63	88	SPKX 060204	P0220500	XT07	⊗
184042900	SCS 20525-3D	20,5	25	62	65	90	SPKX 060204	P0220500	XT07	⊗
184043000	SCS 21025-3D	21,0	25	63	66	91	SPKX 060204	P0220500	XT07	⊗
184043100	SCS 21525-3D	21,5	25	65	68	93	SPKX 060204	P0220500	XT07	⊗
184043200	SCS 22032-3D	22,0	32	66	69	99	SPKX 07T308	P0250704	XT08	⊗
184043300	SCS 22532-3D	22,5	32	68	71	101	SPKX 07T308	P0250704	XT08	⊗
184043400	SCS 23032-3D	23,0	32	69	72	102	SPKX 07T308	P0250704	XT08	⊗
184043500	SCS 23532-3D	23,5	32	71	74	104	SPKX 07T308	P0250704	XT08	⊗
184043600	SCS 24032-3D	24,0	32	72	75	105	SPKX 07T308	P0250704	XT08	⊗
184043700	SCS 24532-3D	24,5	32	74	77	107	SPKX 07T308	P0250704	XT08	⊗
184043800	SCS 25032-3D	25,0	32	75	78	108	SPKX 07T308	P0250704	XT08	⊗
184043900	SCS 25532-3D	25,5	32	77	80	110	SPKX 07T308	P0250704	XT08	⊗
184044000	SCS 26032-3D	26,0	32	78	81	111	SPKX 07T308	P0250704	XT08	⊗
184044100	SCS 26532-3D	26,5	32	80	83	113	SPKX 07T308	P0250704	XT08	⊗
184044200	SCS 27032-3D	27,0	32	81	84	114	SPKX 07T308	P0250704	XT08	⊗
184044400	SCS 27532-3D	27,5	32	83	86	116	SPKX 07T308	P0250704	XT08	⊗

⊗ Stock items / Itens de stock ○ Available under request / Disponibilidade sob consulta / Disponible bajo consulta

SCS 3D Drilling Tool | Ferramenta | Herramienta

Order Code	Reference	Dimensions (mm)					Insert	Screw	Torx Key	Stock
		ØD	Øds	L1	L2	L				
184044500	SCS 28032-3D	28,0	32	84	87	117	SPKX 090408	P0350903	XT15S35	
184044600	SCS 28532-3D	28,5	32	86	89	119	SPKX 090408	P0350903	XT15S35	
184044700	SCS 29032-3D	29,0	32	87	90	120	SPKX 090408	P0350903	XT15S35	
184044800	SCS 29532-3D	29,5	32	89	93	123	SPKX 090408	P0350903	XT15S35	
184044900	SCS 30032-3D	30,0	32	90	95	125	SPKX 090408	P0350903	XT15S35	
184045000	SCS 31032-3D	31,0	32	93	98	128	SPKX 090408	P0350903	XT15S35	
184045100	SCS 32032-3D	32,0	32	96	101	131	SPKX 090408	P0350903	XT15S35	
184045200	SCS 33032-3D	33,0	32	99	104	134	SPKX 090408	P0350903	XT15S35	
184045300	SCS 34040-3D	34,0	40	102	107	142	SPKX 110408	P0401200	XT15S35	
184045400	SCS 35040-3D	35,0	40	105	110	145	SPKX 110408	P0401200	XT15S35	
184045500	SCS 36040-3D	36,0	40	108	113	148	SPKX 110408	P0401200	XT15S35	
184045600	SCS 37040-3D	37,0	40	111	116	151	SPKX 110408	P0401200	XT15S35	
184045700	SCS 38040-3D	38,0	40	114	119	154	SPKX 110408	P0401200	XT15S35	
184045800	SCS 39040-3D	39,0	40	117	122	157	SPKX 110408	P0401200	XT15S35	
184045900	SCS 40040-3D	40,0	40	120	125	160	SPKX 110408	P0401200	XT15S35	
184046000	SCS 41040-3D	41,0	40	123	128	163	SPKX 110408	P0401200	XT15S35	
184046100	SCS 42040-3D	42,0	40	126	131	166	SPKX 140512	P0501300	XT20S40	
184046200	SCS 43040-3D	43,0	40	129	134	169	SPKX 140512	P0501300	XT20S40	
184046300	SCS 44040-3D	44,0	40	132	137	172	SPKX 140512	P0501300	XT20S40	
184046400	SCS 45040-3D	45,0	40	135	140	175	SPKX 140512	P0501300	XT20S40	
184046500	SCS 46040-3D	46,0	40	138	143	178	SPKX 140512	P0501300	XT20S40	
184046600	SCS 47040-3D	47,0	40	141	146	181	SPKX 140512	P0501300	XT20S40	
184046700	SCS 48040-3D	48,0	40	144	149	184	SPKX 140512	P0501300	XT20S40	
184046800	SCS 49040-3D	49,0	40	147	152	187	SPKX 140512	P0501300	XT20S40	
184046900	SCS 50040-3D	50,0	40	150	155	190	SPKX 140512	P0501300	XT20S40	

 Stock items / Itens de stock Available under request / Disponibilidade sob consulta / Disponible bajo consulta

B
Drilling
Indexable Insert Drill
Jet Drill
Integrex Drill
Vortex Drill
Trepanning Drill
Solid Carbide Drill
Inserts
Spare Parts
Technical Data

SCS 4D Drilling Tool | Ferramenta | Herramienta

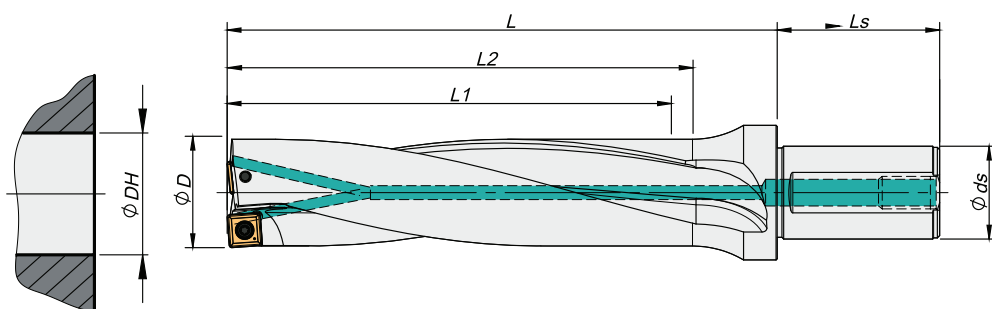

ØDH tolerance (mm)	
ØD	4D
13,0 - 21,5	-0,15 / +0,20
22,0 - 50,0	-0,15 / +0,25



























Øds	Ls	BP / SP
20	50	PT-1/8
25	56	PT-1/8
32	60	PT-1/4
40	70	PT-1/4

Order Code	Reference	Dimensions (mm)					Insert	Screw	Torx Key	Stock
		ØD	Øds	L1	L2	L				
184047100	SCS 13020-4D	13,0	20	52	55	75	SPKX 050204	P0200500	XT06	⊗
184047200	SCS 13520-4D	13,5	20	54	57	77	SPKX 050204	P0200500	XT06	⊗
184047300	SCS 14020-4D	14,0	20	56	59	79	SPKX 050204	P0200500	XT06	⊗
184047400	SCS 14520-4D	14,5	20	58	61	81	SPKX 050204	P0200500	XT06	⊗
184047500	SCS 15020-4D	15,0	20	60	63	83	SPKX 050204	P0200500	XT06	⊗
184047600	SCS 15525-4D	15,5	25	62	65	90	SPKX 060204	P0220500	XT07	⊗
184047700	SCS 16025-4D	16,0	25	64	67	92	SPKX 060204	P0220500	XT07	⊗
184047800	SCS 16525-4D	16,5	25	66	69	94	SPKX 060204	P0220500	XT07	⊗
184047900	SCS 17025-4D	17,0	25	68	71	96	SPKX 060204	P0220500	XT07	⊗
184048000	SCS 17525-4D	17,5	25	70	73	98	SPKX 060204	P0220500	XT07	⊗
184048100	SCS 18025-4D	18,0	25	72	75	100	SPKX 060204	P0220500	XT07	⊗
184048200	SCS 18525-4D	18,5	25	74	77	102	SPKX 060204	P0220500	XT07	⊗
184048300	SCS 19025-4D	19,0	25	76	79	104	SPKX 060204	P0220500	XT07	⊗
184048400	SCS 19525-4D	19,5	25	78	81	106	SPKX 060204	P0220500	XT07	⊗
184048500	SCS 20025-4D	20,0	25	80	83	108	SPKX 060204	P0220500	XT07	⊗
184048600	SCS 20525-4D	20,5	25	82	85	110	SPKX 060204	P0220500	XT07	⊗
184048700	SCS 21025-4D	21,0	25	84	87	112	SPKX 060204	P0220500	XT07	⊗
184048800	SCS 21525-4D	21,5	25	86	89	114	SPKX 060204	P0220500	XT07	⊗
184048900	SCS 22032-4D	22,0	32	88	91	121	SPKX 07T308	P0250704	XT08	⊗
184049000	SCS 22532-4D	22,5	32	90	93	123	SPKX 07T308	P0250704	XT08	⊗
184049100	SCS 23032-4D	23,0	32	92	95	125	SPKX 07T308	P0250704	XT08	⊗
184049200	SCS 23532-4D	23,5	32	94	97	127	SPKX 07T308	P0250704	XT08	⊗
184049300	SCS 24032-4D	24,0	32	96	99	129	SPKX 07T308	P0250704	XT08	⊗
184049400	SCS 24532-4D	24,5	32	98	101	131	SPKX 07T308	P0250704	XT08	⊗
184049500	SCS 25032-4D	25,0	32	100	103	133	SPKX 07T308	P0250704	XT08	⊗
184049600	SCS 25532-4D	25,5	32	102	105	135	SPKX 07T308	P0250704	XT08	⊗
184049700	SCS 26032-4D	26,0	32	104	107	137	SPKX 07T308	P0250704	XT08	⊗
184049800	SCS 26532-4D	26,5	32	106	109	139	SPKX 07T308	P0250704	XT08	⊗
184049900	SCS 27032-4D	27,0	32	108	111	141	SPKX 07T308	P0250704	XT08	⊗
184050000	SCS 27532-4D	27,5	32	110	113	143	SPKX 07T308	P0250704	XT08	⊗

⊗ Stock items / Itens de stock ○ Available under request / Disponibilidade sob consulta / Disponible bajo consulta

B
Drilling
Indexable Insert Drill
Jet Drill
Integrex Drill
Vortex Drill
Trepaming Drill
Solid Carbide Drill
Inserts
Spare Parts
Technical Data

SCS 4D Drilling Tool | Ferramenta | Herramienta

Order Code	Reference	Dimensions (mm)					Insert	Screw	Torx Key	Stock
		ØD	Øds	L1	L2	L				
184050100	SCS 28032-4D	28,0	32	112	115	145	SPKX 090408	P0350903	XT15S35	
184050200	SCS 28532-4D	28,5	32	114	117	147	SPKX 090408	P0350903	XT15S35	
184050300	SCS 29032-4D	29,0	32	116	120	150	SPKX 090408	P0350903	XT15S35	
184050400	SCS 29532-4D	29,5	32	118	123	153	SPKX 090408	P0350903	XT15S35	
184050500	SCS 30032-4D	30,0	32	120	125	155	SPKX 090408	P0350903	XT15S35	
184050600	SCS 31032-4D	31,0	32	124	129	159	SPKX 090408	P0350903	XT15S35	
184050700	SCS 32032-4D	32,0	32	128	133	163	SPKX 090408	P0350903	XT15S35	
184050800	SCS 33032-4D	33,0	32	132	137	167	SPKX 090408	P0350903	XT15S35	
184050900	SCS 34040-4D	34,0	40	136	141	176	SPKX 110408	P0401200	XT15S35	
184051000	SCS 35040-4D	35,0	40	140	145	180	SPKX 110408	P0401200	XT15S35	
184051100	SCS 36040-4D	36,0	40	144	149	184	SPKX 110408	P0401200	XT15S35	
184051200	SCS 37040-4D	37,0	40	148	153	188	SPKX 110408	P0401200	XT15S35	
184051300	SCS 38040-4D	38,0	40	152	157	192	SPKX 110408	P0401200	XT15S35	
184051400	SCS 39040-4D	39,0	40	156	161	196	SPKX 110408	P0401200	XT15S35	
184051500	SCS 40040-4D	40,0	40	160	165	200	SPKX 110408	P0401200	XT15S35	
184051600	SCS 41040-4D	41,0	40	164	169	204	SPKX 110408	P0401200	XT15S35	
184051700	SCS 42040-4D	42,0	40	168	173	208	SPKX 140512	P0501300	XT20S40	
184051800	SCS 43040-4D	43,0	40	172	177	212	SPKX 140512	P0501300	XT20S40	
184051900	SCS 44040-4D	44,0	40	176	181	216	SPKX 140512	P0501300	XT20S40	
184052000	SCS 45040-4D	45,0	40	180	185	220	SPKX 140512	P0501300	XT20S40	
184052100	SCS 46040-4D	46,0	40	184	189	224	SPKX 140512	P0501300	XT20S40	
184052200	SCS 47040-4D	47,0	40	188	193	228	SPKX 140512	P0501300	XT20S40	
184052300	SCS 48040-4D	48,0	40	192	197	232	SPKX 140512	P0501300	XT20S40	
184052400	SCS 49040-4D	49,0	40	196	201	236	SPKX 140512	P0501300	XT20S40	
184052500	SCS 50040-4D	50,0	40	200	205	240	SPKX 140512	P0501300	XT20S40	

 Stock items / Itens de stock  Available under request / Disponibilidade sob consulta / Disponible bajo consulta

B
Drilling
Indexable Insert Drill
Jet Drill
Integrex Drill
Vortex Drill
Trepanning Drill
Solid Carbide Drill
Inserts
Spare Parts
Technical Data

SPKX Inserts | Pastilhas | Plaquetas

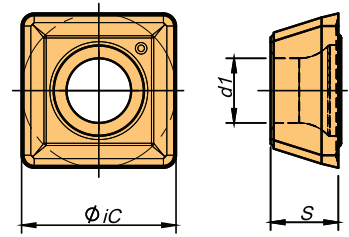
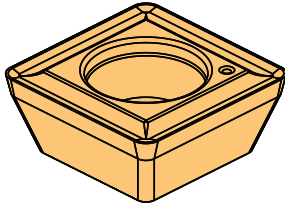

	② Grade Code	Grades																		Dimensions (mm)										
		P						M				K				N		S					H							
		64	54	68	66			I5	68	66	78	86	68	66	I5	D2	67	10	10	D6	54	68	66	64	D4	iC	S	d1		
ISO Ref.	PH6903	PH6910	PH6920	PH6930			PH6740	PH6920	PH6930	PH6125	PH6135	PH6920	PH6930	PH6740	PH6705	PH6325	PH0910	PH0910	PDP410	PH6910	PH6920	PH6930	PH6903	PBH910						
1111281	SPKX 050204			⊗	⊗	○	○		⊗	⊗			⊗	⊗							⊗	⊗						5,00	2,38	2,20
1111282	SPKX 060204			⊗	⊗	○	○		⊗	⊗			⊗	⊗							⊗	⊗						6,00	2,38	2,55
1111283	SPKX 07T308			⊗	⊗	○	○		⊗	⊗			⊗	⊗							⊗	⊗						7,94	3,97	2,85
1111284	SPKX 090408			⊗	⊗	○	○		⊗	⊗			⊗	⊗							⊗	⊗						9,80	4,30	4,10
1111285	SPKX 110408			⊗	⊗	○	○		⊗	⊗			⊗	⊗							⊗	⊗						11,50	4,80	4,40
1111286	SPKX 140512			⊗	⊗	○	○		⊗	⊗			⊗	⊗							⊗	⊗						14,30	5,20	5,75

B
Drilling
Indexable Insert Drill
Jet Drill
Integrex Drill
Vortex Drill
Trepanning Drill
Solid Carbide Drill
Inserts
Spare Parts
Technical Data

⊗ Stock items / Itens de stock ○ Available under request / Disponibilidade sob consulta / Disponible bajo consulta

Insert Order Code = (1) Geometry Code + (2) Grade Code

SCS & SCC Drill Type

Recommended Speeds and Feeds | Parâmetros de Corte Recomendados Recomendaciones de Datos de Corte

ISO	MATERIAL GROUP	Vc (m/min)	ø12,5-15	ø15,5-21,5	ø22-27,5	ø28-33	ø34-41	ø42-50	ø50-60	ø60-75	ø75-80
P	UNALLOYED STEEL (-0,25%)	180-250	0,05-0,08	0,06-0,10	0,06-0,12	0,07-0,13	0,08-0,15	0,08-0,16	0,06-0,12	0,08-0,12	0,08-0,12
	LOW-ALLOY STEEL (0,25%+)	160-220	0,06-0,12	0,08-0,15	0,10-0,18	0,12-0,22	0,12-0,24	0,13-0,25	0,10-0,14	0,12-0,18	0,11-0,18
	LOW-ALLOY STEEL	150-220	0,06-0,12	0,08-0,14	0,10-0,18	0,12-0,22	0,12-0,23	0,13-0,24	0,08-0,15	0,10-0,18	0,10-0,18
	HIGH-ALLOY STEEL	130-180	0,06-0,10	0,08-0,15	0,10-0,20	0,12-0,23	0,12-0,24	0,13-0,25	0,08-0,14	0,09-0,15	0,09-0,14
M	STAINLESS STEEL	170-240	0,05-0,10	0,06-0,12	0,08-0,15	0,09-0,16	0,10-0,17	0,11-0,19	0,06-0,13	0,08-0,15	0,08-0,14
K	GREY CAST IRON	180-250	0,06-0,12	0,08-0,16	0,12-0,20	0,15-0,25	0,16-0,28	0,18-0,30	0,12-0,20	0,15-0,20	0,15-0,20
	CAST IRON WITH NODULAR CAST	130-200	0,06-0,10	0,08-0,15	0,10-0,18	0,12-0,20	0,15-0,23	0,16-0,25	0,10-0,15	0,09-0,18	0,10-0,18
N	ALUMINUM FORGING ALLOYS	330-380	0,06-0,14	0,08-0,15	0,10-0,20	0,12-0,22	0,14-0,23	0,15-0,26	0,14-0,20	0,14-0,23	0,15-0,23
S	SUPER-ALLOYS AND TITANIUM	30-60	0,05-0,10	0,06-0,14	0,08-0,18	0,10-0,22	0,12-0,22	0,14-0,24	0,10-0,15	0,10-0,15	0,10-0,15

Power Requirements | Requisitos de Potência | Requisitos de Potencia

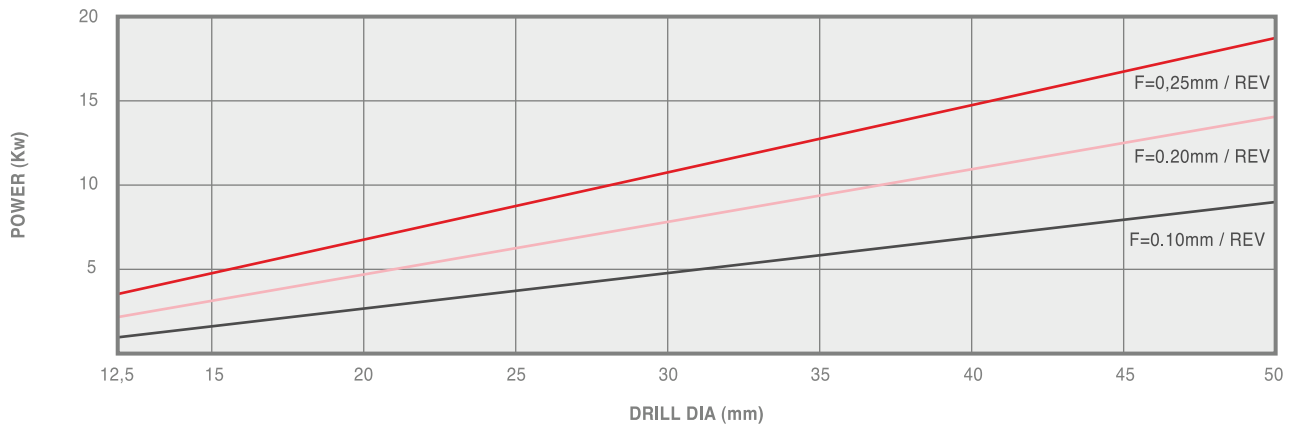

- These chart is based on machining experiences using steels with a hardness of 200-250HB and cutting speed of 100m/min.
- For cast iron the effective power requirement is around 30% lower.

Coolant Application Chart | Tabela Aplicação de Refrigeração | Tabla Aplicación de Refrigerante

